

Spherical roller bearings, cylindrical and tapered bore

Principal dimensions			Basic load ratings		Speed ratings		Designation
d	D	B	dynamic C	static C0	Reference speed	Limiting speed	
mm			kN		r/min		
<b>220</b>	370	120	1888	2750	1300	1700	<b>* SKF Explorer bearing</b> 23144 CCK/W33 *

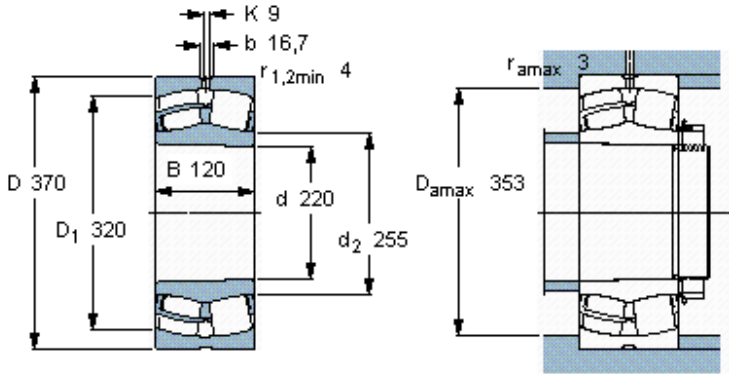

Tapered bore, taper  
1: 12

**Calculation factors**

- e 0,3
- $Y_1$  2,3
- $Y_2$  3,4
- $Y_0$  2,2